



PB340 / PB306 / PB541

Process value indicators and data preset units for PROFIBUS-DP

Product Features:

- The PB340 variant is a simple indicator unit for remote display of all actual data which are available on the connected PROFIBUS network. Arbitrary parameters or actual values can be read or displayed.
- PB306 is a simple data preset unit with front-sided thumbwheel switches. It allows an easy remote setting of single parameters (e. g. speed setting of a drive) via fieldbus. By pressing the ENTER button, the actual BCD setting will be transmitted via PROFIBUS and hold in the polling register for readout.
- PB541 is a combination of preset switch and indicator. While the BCD switch allows to make register changes via PROFIBUS, the LED display provides information about the actual setting of the same or any other register value.

Available Devices:

- PB340: Display unit only
- PB306: Preset unit only
- PB541: Display / Preset combination

Version:	Description:
PB34001c_hk_03/2008	motrona format A5, single language
Pb340_01d_oi_e.doc/Nov-15/ag	"Safety Instructions" and "Legal notices" supplemented "Technical Specifications" and manual-design updated

Legal notices:
All contents included in this manual are protected by the terms of use and copyrights of motrona GmbH. Any reproduction, modification, usage or publication in other electronic and printed media as well as in the internet requires prior written authorization by motrona GmbH.

Table of Contents

1. Safety Instructions and Responsibility	3
1.1 General Safety Instructions.....	3
1.2 Use according to the intended purpose	3
1.3 Installation.....	4
1.4 Cleaning, Maintenance and Service Notes.....	4
2. Introduction	5
3. Block Diagram and Terminal Assignment.....	6
3.1. PROFIBUS connector pin assignment:.....	7
4. Transmission Baud Rate and Unit Address	8
5. Communication.....	9
6. GSD-File	11
7. Technical Specifications	14
8. Dimensions.....	15
8.1. PB306, PB340:	15
8.2. PB541:.....	15

1. Safety Instructions and Responsibility

1.1 General Safety Instructions

This operation manual is a significant component of the unit and includes important rules and hints about the installation, function and usage. Non-observance can result in damage and/or impairment of the functions to the unit or the machine or even in injury to persons using the equipment!

Please read the following instructions carefully before operating the device and observe all safety and warning instructions! Keep the manual for later use.

A pertinent qualification of the respective staff is a fundamental requirement in order to use these manual. The unit must be installed, connected and put into operation by a qualified electrician.

Liability exclusion: The manufacturer is not liable for personal injury and/or damage to property and for consequential damage, due to incorrect handling, installation and operation. Further claims, due to errors in the operation manual as well as misinterpretations are excluded from liability.

In addition the manufacturer reserve the right to modify the hardware, software or operation manual at any time and without prior notice. Therefore, there might be minor differences between the unit and the descriptions in operation manual.

The raiser respectively positioner is exclusively responsible for the safety of the system and equipment where the unit will be integrated.

During installation or maintenance all general and also all country- and application-specific safety rules and standards must be observed.

If the device is used in processes, where a failure or faulty operation could damage the system or injure persons, appropriate precautions to avoid such consequences must be taken.

1.2 Use according to the intended purpose

The unit is intended exclusively for use in industrial machines, constructions and systems. Non-conforming usage does not correspond to the provisions and lies within the sole responsibility of the user. The manufacturer is not liable for damages which has arisen through unsuitable and improper use.

Please note that device may only be installed in proper form and used in a technically perfect condition - in accordance to the Technical Specifications (see chapter [7](#)). The device is not suitable for operation in explosion-proof areas or areas which are excluded by the EN 61010-1 standard.

1.3 Installation

The device is only allowed to be installed and operated within the permissible temperature range. Please ensure an adequate ventilation and avoid all direct contact between the device and hot or aggressive gases and liquids.

Before installation or maintenance, the unit must be disconnected from all voltage-sources. Further it must be ensured that no danger can arise by touching the disconnected voltage-sources.

Devices which are supplied by AC-voltages, must be connected exclusively by switches, respectively circuit-breakers with the low voltage network. The switch or circuit-breaker must be placed as near as possible to the device and further indicated as separator.

Incoming as well as outgoing wires and wires for extra low voltages (ELV) must be separated from dangerous electrical cables (SELV circuits) by using a double resp. increased isolation.

All selected wires and isolations must be conform to the provided voltage- and temperature-ranges. Further all country- and application-specific standards, which are relevant for structure, form and quality of the wires, must be ensured. Indications about the permissible wire cross-sections for wiring are described in the Technical Specifications (see chapter [7](#)).

Before first start-up it must be ensured that all connections and wires are firmly seated and secured in the screw terminals. All (inclusively unused) terminals must be fastened by turning the relevant screws clockwise up to the stop.

Overvoltages at the connections must be limited to values in accordance to the overvoltage category II.

For placement, wiring, environmental conditions as well as shielding and earthing/grounding of the supply lines the general standards of industrial automation industry and the specific shielding instructions of the manufacturer are valid. Please find all respective hints and rules on www.motrona.com/download.html --> "[General EMC Rules for Wiring, Screening and Earthing]".

1.4 Cleaning, Maintenance and Service Notes

To clean the front of the unit please use only a slightly damp (not wet!), soft cloth. For the rear no cleaning is necessary. For an unscheduled, individual cleaning of the rear the maintenance staff or assembler is self-responsible.

During normal operation no maintenance is necessary. In case of unexpected problems, failures or malfunctions the device must be shipped for back to the manufacturer for checking, adjustment and reparation (if necessary). Unauthorized opening and repairing can have negative effects or failures to the protection-measures of the unit.

2. Introduction

The PB340 / PB306 / PB541 series has been designed for display and/or remote preset of single parameters or registers (e.g. display of actual position or preset of line speed) in systems using a PROFIBUS-DP network.

These units operate as PROFIBUS-DP slaves according to EN 50 170.

- **PB340** is a display unit with a 6 decade, 15mm (0.59") size LED-display.
- **PB306** is a 6 decade BCD thumbwheel switch set with a range of 0 ... 999 999 *).
- **PB541** is a combination of both, PB340 and PB306, providing a display and a BCD thumbwheel switch set *).

All units are built into DIN housings for front panel mounting.



A printout of the GSD file necessary for the use of this unit can be found under section [6](#). of this manual. The file itself is available on the CD supplied with every unit.

You can also download this file at any time from the **DOWNLOAD** site of our homepage: <http://www.motrona.com>

*) With supplementary ordering information "**Option VZ000**" the unit is available as a 5 decade plus sign version (setting range -99999 to +99999)

3. Block Diagram and Terminal Assignment

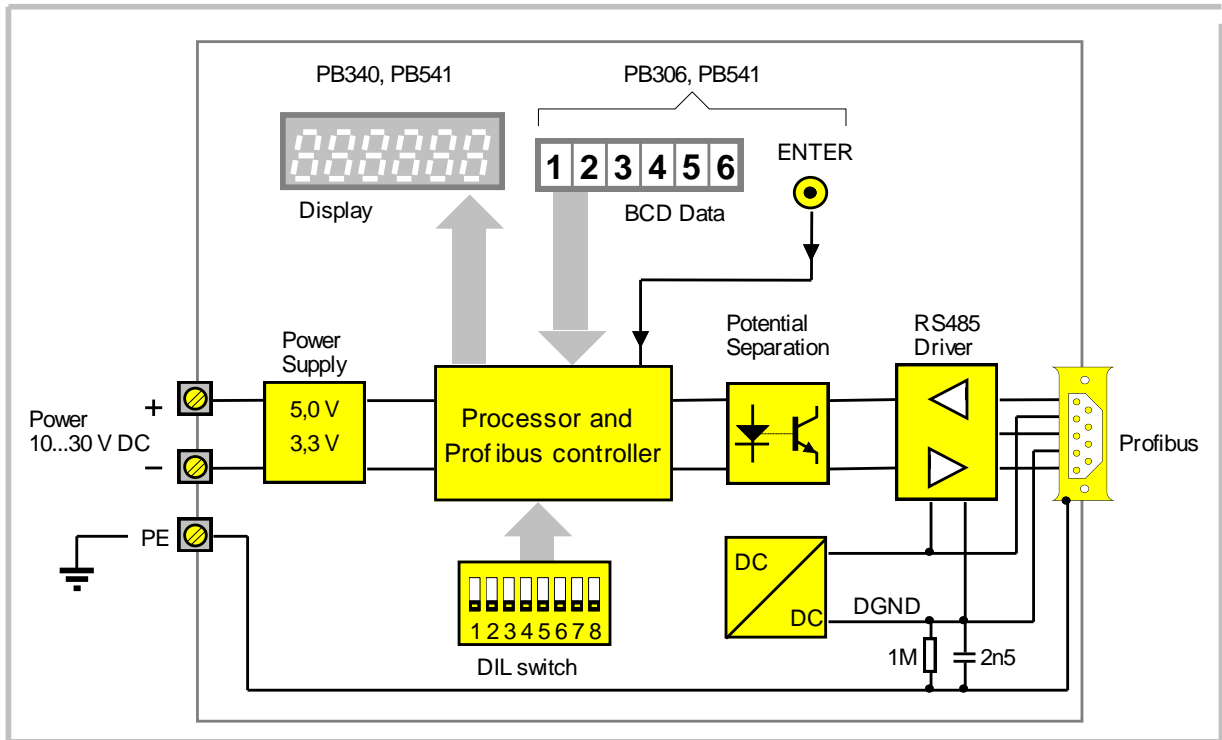

Power supply screw terminals, PROFIBUS connector and DIL switches for setup are located on the backplane of the unit.

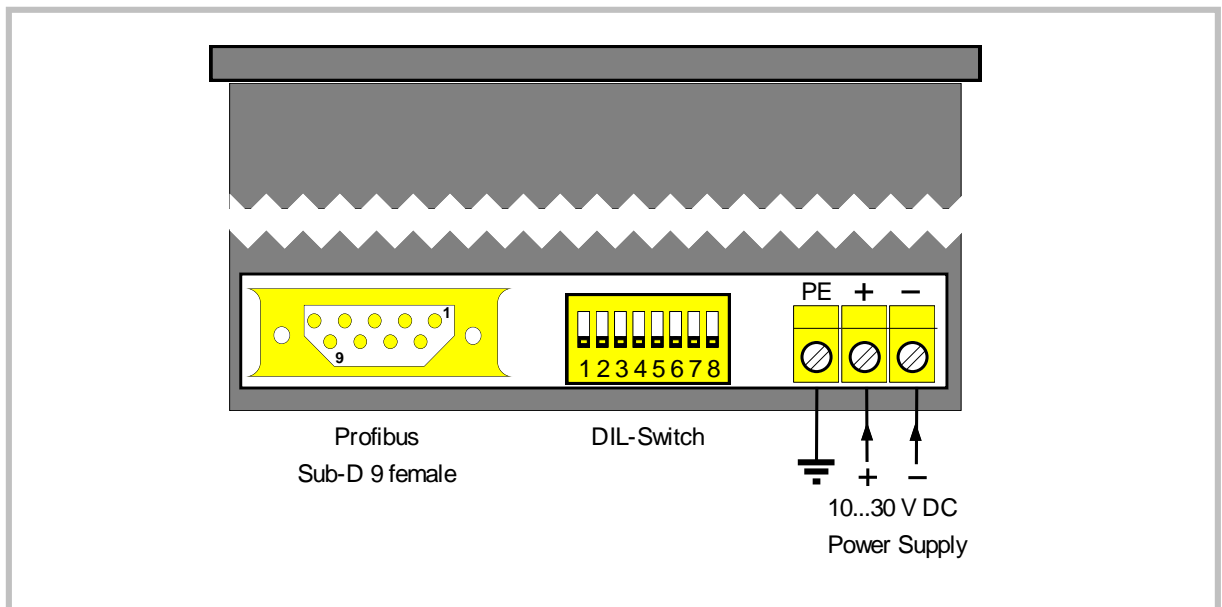

3.1. PROFIBUS connector pin assignment:

Pin:	Signal:	Function:
1	Screen	Screen / Earth connection
2	n. c.	–
3	RxD/TxD-P	Data +
4	CNTR-P (RTS)	Request To Send
5	DGND	Reference Potential (Ground)
6	VP	Power supply + 5 V / 50 mA
7	n. c.	–
8	RxD/TxD-N	Data -
9	n. c.	–

The following cables are recommended for PROFIBUS (EN 50 170 "Type-A cable"):

Impedance:	135 ... 165 Ω
Capacitance:	< 30 pF / m
Loop resistance:	< 110 Ω / km
Wire diameter:	> 0,64 mm (0.025")
Conductor cross section:	> 0,34 mm ²

Depending on the Baud rate, the following maximum cable length must not be exceeded:

Baud rate (kbit / s)	9,6	19,2	93,75	187,5	500	1500	3000	6000	12000
Max. cable length (m)	1200			1000	400	200	100		



The PROFIBUS line must be terminated by a resistor network on the extreme ends of the cable (i.e. on the first unit and on the last unit). The shield of the cable must be connected to protection earth.

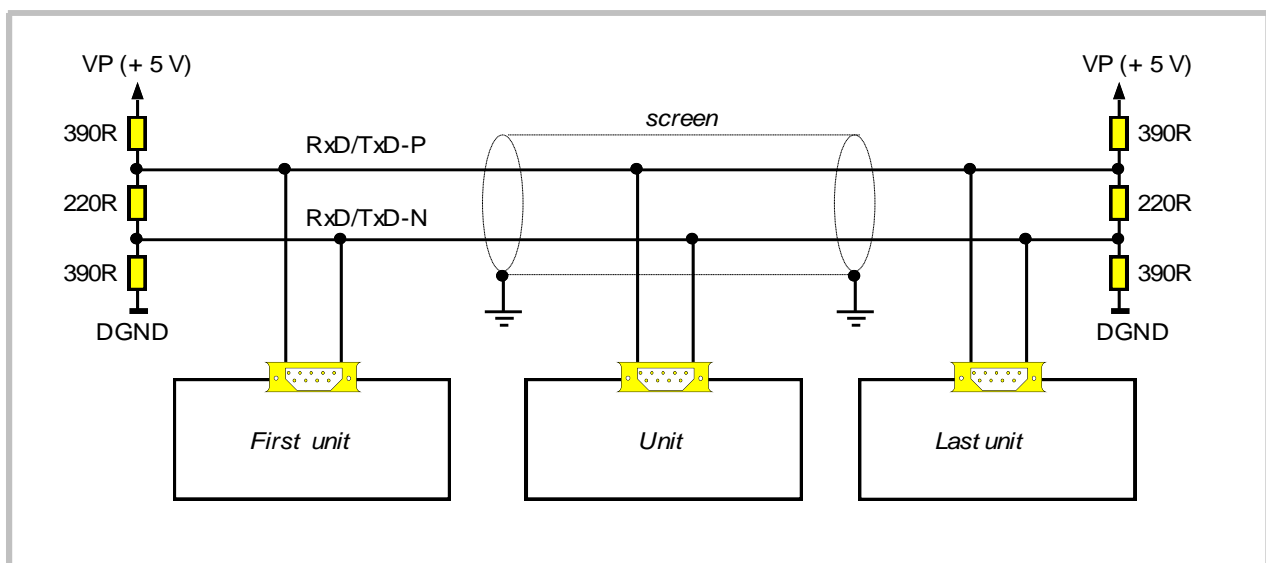

4. Transmission Baud Rate and Unit Address

The unit does not require a Baud rate preset because the baud rate of the network will be automatically recognized while the communication is starting up. All PROFIBUS-DP baud rates from 9.6 kbit/s to 12 Mbit/s are supported.

Positions 2...7 of the DIL switch select the unit address, value range 3...126. This address cannot be changed by the master by the Set_Slave_Address service.

Switch position 1 defines the most significant digit of the front thumbwheel switches to be transmitted as a numeral or a sign (PB306 and PB541 only).

Version providing a sign (option VZ000) require position 1 to be set to "ON"!

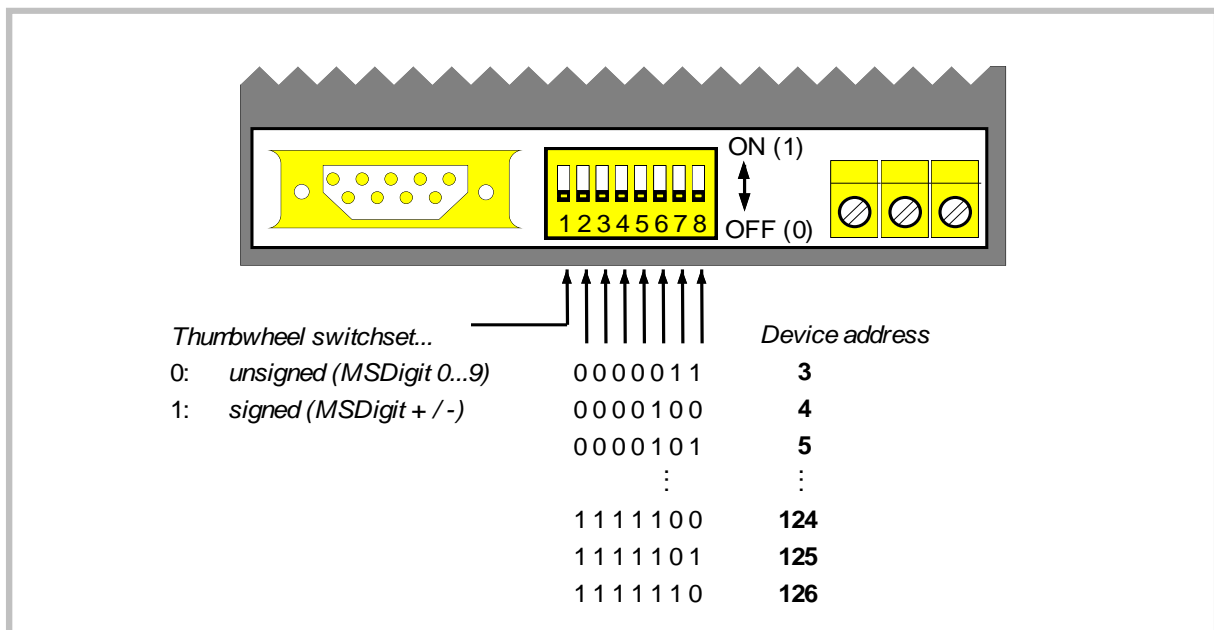

DIL switch settings are only read upon initialization. Changes during normal operation will not be recognized! After change of DIL switch settings you must therefore cycle the power supply of the unit.

5. Communication

During start-up of the communication the master must transmit the **configuration data** according to the unit type:

Unit Type:	Configuration Data:	Meaning:
PB340	A3 hex	4 byte output data
PB306	93 hex	4 byte input data
PB541	B3 hex	4 byte input data + 4 byte output data

When transmitting the **parameter data** to the unit, the position of the decimal point in display can be set by the user parameter "decimal point":

status	wd_fact_1	wd_fact_2	tsdr	Ident high	Ident low	group_Ident	"decimal point"
PROFIBUS-DP parameter data (→ EN 50 170)							1 byte user parameter data

The diagnosis data provide 6 bytes of PROFIBUS-DP diagnosis data and 5 byte of device specific diagnosis data

diag 1	diag 2	diag 3	diag 4	Ident high	Ident low	sign_len = 05 hex	status_type = 81 hex	slot_nr= 00	specifier = 00	error = XX
PROFIBUS-DP diagnosis data (→ EN 50 170)						device specific diagnosis data ("State PDU")				

After successful start-up the data communication begins. Both input and output data are transmitted as signed 32-bit data.

Received output data (PB340, PB541) will be displayed immediately. When the display value range of -99999 ... 999999 is exceeded, "-----" will appear in the display.

With PB306 and PB541 units the data of the thumbwheel switch set will be transferred to the input data buffer upon pressing the ENTER button, and then transmitted with the next cycle.

The actual communication state of the slave unit is indicated by display (PB340, PB541) or by the front LED (PB306):

Display: (PB340, PB541)	LED: (PB306)	PROFIBUS-DP state:	Device state:
" "	off	Power_on	initialization
" - - - - - "	flashing slowly	Wait_Prm Wait_Cfg	Ready, waiting for start-up
"XXXXXX" (output data)	on	Data_Exchange	Communication active
"_EXXX_"	flashing quickly	(Power_on)	Fatal Error

A fatal error can be reset only by switching of power supply.

6. GSD-File

```
.*****
;
;
;   GSD-File for PB340/306/541
;
;   File:          mksr0553.gsd
;   Version:       02
;   Date:          07.01.2008
;   Author:        Thomas Jaeckle
;
;   motrona GmbH
;   www.motrona.com
;
.*****
;
;
;#PROFIBUS_DP
;
;
; <Ext-User-Prm-Data-Def-List>
;
ExtUserPrmData = 1 "decimal point"           ; User parameter: Display Decimal Point
Unsigned8 0 0-5                               ; Default value: 0, value range: 0...5
EndExtUserPrmData
;
;
;General parameters:
;
GSD_Revision = 1
Vendor_Name = "motrona"
Model_Name = "PB340/306/541"
Revision = "01"
Ident_Number = 0x0553
Protocol_Ident = 0                             ; PROFIBUS-DP
Station_Type = 0                               ; Slave
FMS_supp = 0                                  ; No FMS supported
Hardware_Release = "340PB11"
Software_Release = "01"
```

```

;
9.6_supp = 1 ; Supported baud rates
19.2_supp = 1
93.75_supp = 1
187.5_supp = 1
500_supp = 1
1.5M_supp = 1
3M_supp = 1
6M_supp = 1
12M_supp = 1
;
MaxTcdr_9.6 = 60
MaxTcdr_19.2 = 60
MaxTcdr_93.75 = 60
MaxTcdr_187.5 = 60
MaxTcdr_500 = 100
MaxTcdr_1.5M = 150
MaxTcdr_3M = 250
MaxTcdr_6M = 450
MaxTcdr_12M = 800
;
Redundancy = 0
Repeater_Ctrl_Sig = 2 ; RTS-Signal (CNTR-P): TTL-level
24V_Pins = 0 ; No 24V supply on PROFIBUS-connector
Implementation_Type = "DPC31"
;
;
; Slave-Specification:
;
Freeze_Mode_supp = 1 ; Freeze-Mode supported
Sync_Mode_supp = 1 ; Sync-Mode supported
Set_Slave_Add_Supp = 0 ; Set_Slave_Address not supported
Auto_Baud_supp = 1 ; Automatic baudrate recognition
Min_Slave_Intervall = 10
Fail_Safe = 1 ; Fail-Save-Mode supported
Max_Diag_Data_Len = 11 ; 5 byte user diagnostic data
Modul_Offset = 0
Slave_Family = 6 ; HMI unit
Modular_Station = 1

```

```

Max_Module = 1 ; Modular station with one module
Max_Input_len = 4 ; 32 bit input data (PB306/541)
Max_Output_len = 4 ; 32 bit output data (PB340/541)
Max_Data_len = 8 ; Max. 2 * 32 bit data (PB541)
;
; UserPrmData:
;
Max_User_Prm_Data_Len = 1 ; 1 byte user parameter data
;
; Module Definition List:
;
Module="PB340" 0xA3 ; Config. PB340: 4 byte output data
Ext_Module_Prm_Data_Len = 1
Ext_User_Prm_Data_Const(0) = 0x00
Ext_User_Prm_Data_Ref(0) = 1
EndModule
;
Module="PB306" 0x93 ; Config. PB306: 4 byte input data
Ext_Module_Prm_Data_Len = 1
Ext_User_Prm_Data_Const(0) = 0x00
EndModule
;
Module="PB541" 0xB3 ; Config. PB541: 4 byte input data +
; 4 byte output data
Ext_Module_Prm_Data_Len = 1
Ext_User_Prm_Data_Const(0) = 0x00
Ext_User_Prm_Data_Ref(0) = 1
EndModule

```

7. Technical Specifications

Power supply:	Input voltage: 10 ... 30 VDC Protection circuit: reverse polarity protection Consumption: PB306 approx. 70 mA (at 24 V) PB340 / 541: approx. 100 mA (at 24 V) Connections: screw terminal, 1,5 mm ² / AWG 16
Bus connection:	Communication profile: PROFIBUS-DP Slave, EN 50 170 Identity number: 0553 hex Device data file: mksr0553.gsd Baud Rates (selectable): 9.6 / 19.2 / 93.75 / 187.5 / 500 kbit/s, 1.5 / 3 / 6 / 12 Mbit/s
BCD switch PB306 / 541:	Adjustment range: 0 ... 999 999 (standard) - 99 999 ... + 99 999 (Option VZ000)
Display PB340 / 541:	Range: - 99 999 ... 999 999 Type: LED, red, seven segments Digit height: 14 mm / 0.551 inch Number of digits: 6
Housing:	Material: plastic Mounting: panel Dimensions: PB306: outer dimensions (w x h x d): 96 x 48 x 120 mm / 3.78 x 1.89 x 4.72 inch cut out (w x h): 92 x 43 mm / 3.62 x 1.69 inch PB340: outer dimensions (w x h x d): 96 x 48 x 149 mm / 3.78 x 1.89 x 5.87 inch cut out (w x h): 92 x 43 mm / 3.62 x 1.69 inch PB541: outer dimensions (w x h x d): 96 x 72 x 149 mm / 3.78 x 2.83 x 5.87 inch cut out (w x h): 92 x 67 mm / 3.62 x 2.64 inch Protection class: PB340*: front side: IP 44 / rear: IP20 PB306* / 541: front side: IP 40 / rear: IP20 * IP 65 (front side) is available as an option Weight: PB306 / 340: approx. 270 g PB541: approx. 350 g
Temperature range:	Operation: 0 °C ... +45 °C / +32 ... +113 °F (not condensing) Storage: -25 °C ... +70 °C / -13 ... +158 °F (not condensing)
Failure rate:	MTBF in years: PB340 : 55,9 a / PB306 : 59,1 a / PB541 : 43,5 a (long-term usage at 60 °C / 140 °F)
Conformity & standards:	EMC 2004/108/EC: EN 61000-6-2, EN 61000-6-3, EN 61000-6-4 Guideline 2011/65/EU: RoHS-conform

8. Dimensions

8.1. PB306, PB340:

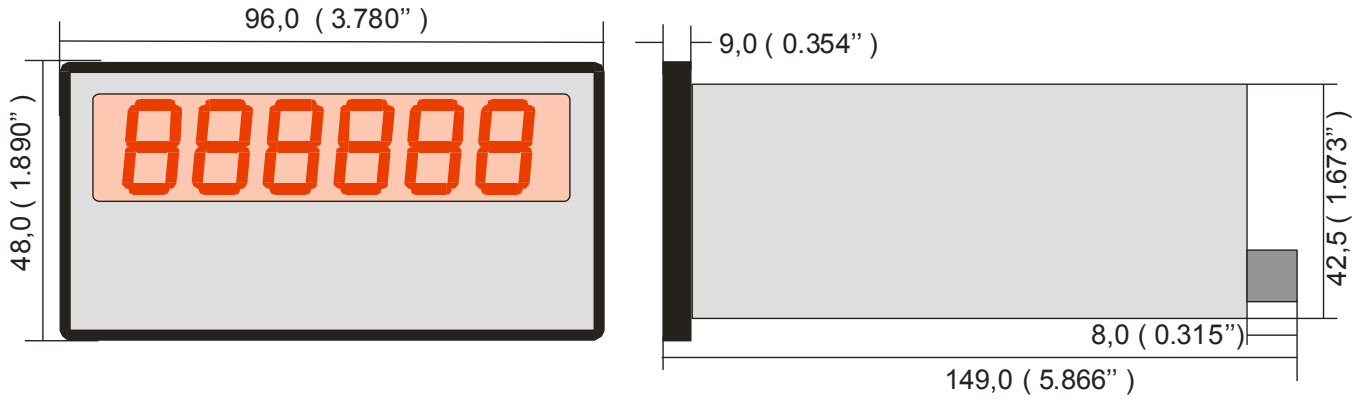

Cut out: 92 x 43 mm (3.622 x 1.693")

8.2. PB541:

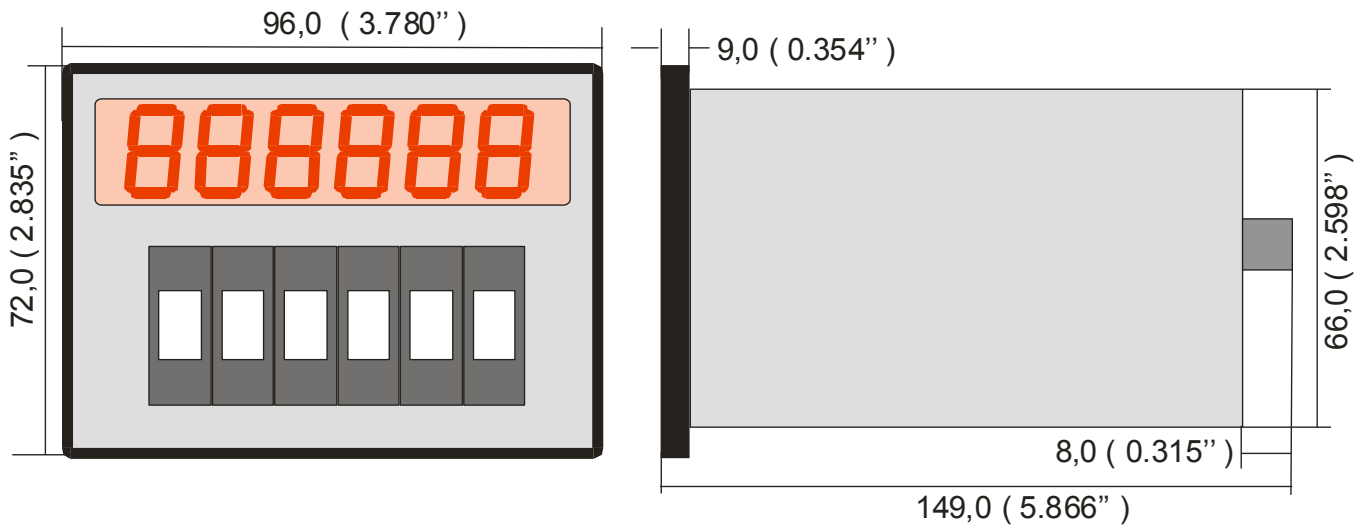

Cut out: 92 x 67 mm (3.622 x 2.638")